



# Ultra Low Noise, Low offset Drift $\pm 1 g$ Dual Axis Accelerometer with Digital Outputs

## MXD2020E/F

### FEATURES

- Resolution better than 1 mg at 1 Hz
- Dual axis accelerometer fabricated on a monolithic CMOS IC
- RoHS compliant
- On-chip mixed mode signal processing
- 50,000 *g* shock survival rating
- 17 Hz bandwidth
- 3.00V to 5.25V single supply operation
- Small (5mm x 5mm x 2mm) surface mount package
- Continuous self-test
- Independent axis programmability (special order)

### APPLICATIONS

- Automotive** – Vehicle Security/Active Suspension/ABS  
Headlight Angle Control/Tilt Sensing
- Security** – Gas Line/Elevator/Fatigue Sensing
- Office Equipment** – Computer Peripherals/PDA's/Cell Phones
- Gaming** – Joystick/RF Interface/Menu Selection/Tilt Sensing
- Projectors** - Leveling and Keystoning
- White Goods** – Spin/Vibration Control

### GENERAL DESCRIPTION

The MXD2020E/F is an ultra low noise and low cost, dual axis accelerometer built on a standard, submicron CMOS process. The MXD2020E/F measures acceleration with a full-scale range of  $\pm 1 g$  and a sensitivity of 20%/g @5V at 25°C. It can measure both dynamic acceleration (e.g., vibration) and static acceleration (e.g., gravity). The MXD2020E/F design is based on heat convection and requires no solid proof mass. This eliminates stiction and particle problems associated with competitive devices and provides shock survival up to 50,000 *g*, leading to significantly lower failure rates and lower losses due to handling during assembly.

The MXD2020E/F provides two digital outputs. The outputs are digital signals with duty cycles (ratio of pulse width to period) that are proportional to acceleration. The duty cycles outputs can be directly interfaced to a micro-processor.

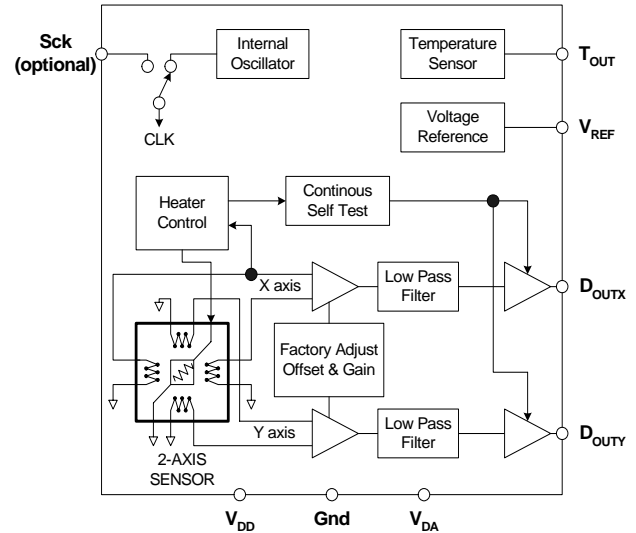

MXD2020E/F FUNCTIONAL BLOCK DIAGRAM

The typical noise floor is  $0.2\text{mg} / \sqrt{\text{Hz}}$  allowing signals below 1mg to be resolved at 1 Hz bandwidth. The MXD2020E/F is available in a LCC surface mount package (5mm x 5mm x 2mm height). It is hermetically sealed and operational over a  $-40^\circ\text{C}$  to  $+105^\circ\text{C}$  temperature range.

Due to the standard CMOS structure of the MXD2020E/F, additional circuitry can easily be incorporated into custom versions for high volume applications. Contact the factory for more information.

Information furnished by MEMSIC is believed to be accurate and reliable. However, no responsibility is assumed by MEMSIC for its use, nor for any infringements of patents or other rights of third parties, which may result from its use. No license is granted by implication or otherwise under any patent or patent rights of MEMSIC

**MXD2020E/F SPECIFICATIONS** (Measurements @ 25°C, Acceleration = 0g unless otherwise noted, V<sub>DD</sub>, V<sub>DA</sub> = 5.0V unless otherwise specified)

Parameter	Conditions	MXD2020E/F			Units
		Min	Typ	Max	
<b>SENSOR INPUT</b>	Each Axis				
Measurement Range <sup>1</sup>		±1.0			g
Nonlinearity	Best fit straight line		0.5	1.0	% of FS
Alignment Error <sup>2</sup>			±1.0		degrees
Transverse Sensitivity <sup>3</sup>			±2.0		%
<b>SENSITIVITY</b>	Each Axis				
D <sub>OUTX</sub> and D <sub>OUTY</sub>	@5.0V supply	19.0	20.0	21.0	% Duty Cycle/g
Change over Temperature (uncompensated) <sup>4</sup>	Δ from 25°C, at -40°C			+120	%
	Δ from 25°C, at +105°C	-55			%
Change over Temperature (compensated) <sup>4</sup>	Δ from 25°C, -40°C to +105°C		<3.0		%
<b>ZERO g BIAS LEVEL</b>	Each Axis				
0 g Offset <sup>5</sup>		-0.1	0.00	+0.1	g
0 g Duty Cycle <sup>5</sup>		48	50	52	% Duty Cycle
0 g Offset over Temperature	Δ from 25°C		±0.4		mg/°C
	Δ based on 20%/g		±0.008		% / °C
<b>PWM output Frequency</b>	For MXD2020EL only	97	100	103	Hz
	MXD2020E	95	100	105	Hz
	MXD2020F	380	400	420	Hz
<b>NOISE PERFORMANCE</b>					
Noise Density, rms			0.2	0.4	mg/√Hz
<b>FREQUENCY RESPONSE</b>					
3dB Bandwidth		15	17	19	Hz
<b>TEMPERATURE OUTPUT</b>					
T <sub>out</sub> Voltage		1.15	1.25	1.35	V
Sensitivity		4.6	5.0	5.4	mV/°K
<b>VOLTAGE REFERENCE OUTPUT</b>					
V <sub>Ref</sub> output	@3.0V-5.25V supply	2.4	2.5	2.65	V
Change over Temperature			0.1		mV/°C
Current Drive Capability	Source			100	μA
<b>SELF TEST</b>					
Continuous Voltage at D <sub>OUTX</sub> , D <sub>OUTY</sub> under Failure	@5.0V Supply, output rails to supply voltage		5.0		V
Continuous Voltage at D <sub>OUTX</sub> , D <sub>OUTY</sub> under Failure	@3.0V Supply, output rails to supply voltage		3.0		V
<b>D<sub>OUTX</sub> and D<sub>OUTY</sub> OUTPUTS</b>					
Normal Output Range	Output High	4.8			V
	Output Low			0.2	V
Current	Source or sink, @ 3.0V-5.25V supply			100	μA
Rise/Fall Time	3.0 to 5.0V Supply	90	100	110	nS
Turn-on Time	@5.0V Supply		160		mS
	@3.0V Supply		300		mS
<b>POWER SUPPLY</b>					
Operating Voltage Range		3.0		5.25	V
Supply Current	@ 5.0V	2.7	3.3	4.1	mA
Supply Current	@ 3.0V	3.2	4.0	4.8	mA
<b>TEMPERATURE RANGE</b>					
Operating Range		-40		+105	°C

**NOTES**

<sup>1</sup> Guaranteed by measurement of initial offset and sensitivity.

<sup>2</sup> Alignment error is specified as the angle between the true and indicated axis of sensitivity.

<sup>3</sup> Transverse sensitivity is the algebraic sum of the alignment and the inherent sensitivity errors

<sup>4</sup> The sensitivity change over temperature for thermal accelerometers is based on variations in heat transfer that are governed by the laws of physics and it is highly consistent from device to device. Please refer to the section in this data sheet titled "Compensation for the Change of Sensitivity over Temperature" for more information.

<sup>5</sup> The device operates over a 3.0V to 5.25V supply range. Please note that sensitivity and zero g bias level will be slightly different at 3.0V operation. For devices to be operated at 3.0V in production they can be trimmed at the factory specifically for this lower supply voltage operation, in which case the sensitivity and zero g bias level specifications on this page will be met. Please contact the factory for specially trimmed devices for low supply voltage operation.

<sup>6</sup> Output settled to within ±17mg.

**ABSOLUTE MAXIMUM RATINGS\***

Supply Voltage ( $V_{DD}$ ,  $V_{DA}$ ) .....-0.5 to +7.0V  
 Storage Temperature .....-65°C to +150°C  
 Acceleration .....50,000 g

\*Stresses above those listed under Absolute Maximum Ratings may cause permanent damage to the device. This is a stress rating only; the functional operation of the device at these or any other conditions above those indicated in the operational sections of this specification is not implied. Exposure to absolute maximum rating conditions for extended periods may affect device reliability.

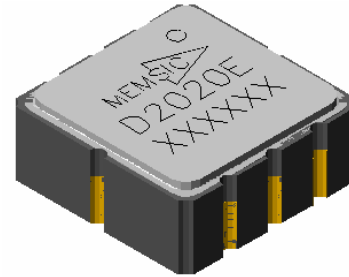

**Package Characteristics**

Package	$\theta_{JA}$	$\theta_{JC}$	Device Weight
LCC-8	110°C/W	22°C/W	< 1 gram

**Ordering Guide**

Model	Package Style	Digital Output
MXD2020EL	LCC8 RoHS compliant	100 Hz
MXD2020EF	LCC8, Pb-free RoHS compliant	100Hz
MXD2020FL	LCC8 RoHS compliant	400 Hz
MXD2020FF	LCC8, Pb-free RoHS compliant	400Hz

All parts are shipped in tape and reel packaging.

**Caution**

ESD (electrostatic discharge) sensitive device.

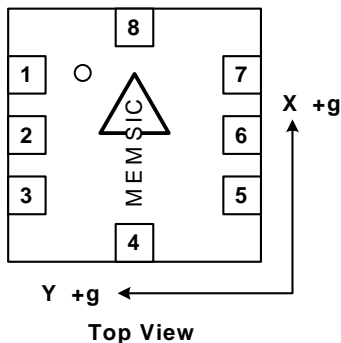

**Note:** The MEMSIC logo's arrow indicates the +X sensing direction of the device. The +Y sensing direction is rotated 90° away from the +X direction. Small circle indicates pin one (1).

**Pin Description: LCC-8 Package**

Pin	Name	Description	I/O
1	$T_{OUT}$	Temperature (Analog Voltage)	O
2	$D_{OUTY}$	Y-Axis Acceleration Digital Signal	O
3	Gnd	Ground	I
4	$V_{DA}$	Analog Supply Voltage	I
5	$D_{OUTX}$	X-Axis Acceleration Digital Signal	O
6	$V_{ref}$	2.5V Reference Output	O
7	Sck	Optional External Clock	I
8	$V_{DD}$	Digital Supply Voltage	I

**THEORY OF OPERATION**

The MEMSIC device is a complete dual-axis acceleration measurement system fabricated on a monolithic CMOS IC process. The device operation is based on heat transfer by natural convection and operates like other accelerometers having a proof mass except it is a gas in the MEMSIC sensor.

A single heat source, centered in the silicon chip is suspended across a cavity. Equally spaced aluminum/polysilicon thermopiles (groups of thermocouples) are located equidistantly on all four sides of the heat source (dual axis). Under zero acceleration, a temperature gradient is symmetrical about the heat source, so that the temperature is the same at all four thermopiles, causing them to output the same voltage.

Acceleration in any direction will disturb the temperature profile, due to free convection heat transfer, causing it to be asymmetrical. The temperature, and hence voltage output of the four thermopiles will then be different. The differential voltage at the thermopile outputs is directly proportional to the acceleration. There are two identical acceleration signal paths on the accelerometer, one to measure acceleration in the x-axis and one to measure acceleration in the y-axis. Please visit the MEMSIC website at [www.memsic.com](http://www.memsic.com) for a picture/graphic description of the free convection heat transfer principle.

## PIN DESCRIPTIONS

**V<sub>DD</sub>** – This is the supply input for the digital circuits and the sensor heater in the accelerometer. The DC voltage should be between 3.00 and 5.25 volts. Refer to the section on PCB layout and fabrication suggestions for guidance on external parts and connections recommended.

**V<sub>DA</sub>** – This is the power supply input for the analog amplifiers in the accelerometer. Refer to the section on PCB layout and fabrication suggestions for guidance on external parts and connections recommended.

**Gnd** – This is the ground pin for the accelerometer.

**D<sub>OUTX</sub>** – This pin is the digital output of the x-axis acceleration sensor. It is factory programmable to 100 Hz or 400 Hz. The user should ensure the load impedance is sufficiently high as to not source/sink >100µA typical. While the sensitivity of this axis has been programmed at the factory to be the same as the sensitivity for the y-axis, the accelerometer can be programmed for non-equal sensitivities on the x- and y-axes. Contact the factory for additional information.

**D<sub>OUTY</sub>** – This pin is the digital output of the y-axis acceleration sensor. It is factory programmable to 100 Hz or 400 Hz. The user should ensure the load impedance is sufficiently high as to not source/sink >100µA typical. While the sensitivity of this axis has been programmed at the factory to be the same as the sensitivity for the x-axis, the accelerometer can be programmed for non-equal sensitivities on the x- and y-axes. Contact the factory for additional information.

**T<sub>OUT</sub>** – This pin is the buffered output of the temperature sensor. The analog voltage at T<sub>OUT</sub> is an indication of the die temperature. This voltage is useful as a differential measurement of temperature from ambient and not as an absolute measurement of temperature. After correlating the voltage at T<sub>OUT</sub> to 25°C ambient, the change in this voltage due to changes in the ambient temperature can be used to compensate for the change over temperature of the accelerometer offset and sensitivity. Please refer to the section on Compensation for the Change in Sensitivity Over Temperature for more information.

**Sck** – The standard product is delivered with an internal clock option (800kHz). **This pin should be grounded when operating with the internal clock.** An external clock option can be special ordered from the factory allowing the user to input a clock signal between 400kHz And 1.6MHz

**V<sub>ref</sub>** – This pin is the output of a reference voltage. It is set at 2.50V typical and has 100µA of drive capability.

## COMPENSATION FOR THE CHANGE IN SENSITIVITY OVER TEMPERATURE

All thermal accelerometers display the same sensitivity change with temperature. The sensitivity change depends on variations in heat transfer that are governed by the laws of physics. Manufacturing variations do not influence the sensitivity change, so there are no unit-to-unit differences in sensitivity change. The sensitivity change is governed by the following equation (and shown in Figure 1 in °C):

$$S_i \times T_i^{2.90} = S_f \times T_f^{2.90}$$

where S<sub>i</sub> is the sensitivity at any initial temperature T<sub>i</sub>, and S<sub>f</sub> is the sensitivity at any other final temperature T<sub>f</sub> with the temperature values in K.

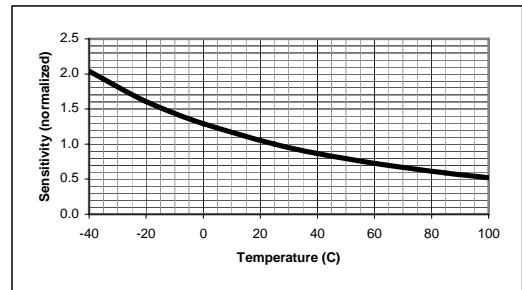

Figure 1: Thermal Accelerometer Sensitivity

In gaming applications where the game or controller is typically used in a constant temperature environment, sensitivity might not need to be compensated in hardware or software. The compensation for this effect could be done instinctively by the game player.

For applications where sensitivity changes of a few percent are acceptable, the above equation can be approximated with a linear function. Using a linear approximation, an external circuit that provides a gain adjustment of -0.9%/°C would keep the sensitivity within 10% of its room temperature value over a 0°C to +50°C range.

For applications that demand high performance, a low cost micro-controller can be used to implement the above equation. A reference design using a Microchip MCU (p/n 16F873/04-SO) and MEMSIC developed firmware is available by contacting the factory. With this reference design, the sensitivity variation over the full temperature range (-40°C to +105°C) can be kept below 3%. Please visit the MEMSIC web site at [www.memsic.com](http://www.memsic.com) for reference design information on circuits and programs including look up tables for easily incorporating sensitivity compensation.

## DISCUSSION OF TILT APPLICATIONS AND RESOLUTION

**Tilt Applications:** One of the most popular applications of the MEMSIC accelerometer product line is in tilt/inclination measurement. An accelerometer uses the

force of gravity as an input to determine the inclination angle of an object.

A MEMSIC accelerometer is most sensitive to changes in position, or tilt, when the accelerometer's sensitive axis is perpendicular to the force of gravity, or parallel to the Earth's surface. Similarly, when the accelerometer's axis is parallel to the force of gravity (perpendicular to the Earth's surface), it is least sensitive to changes in tilt.

Table 1 and Figure 2 to help illustrate the output changes in the X- and Y-axes as the unit is tilted from +90° to 0°. Notice that when one axis has a small change in output per degree of tilt (in mg), the second axis has a large change in output per degree of tilt. The complementary nature of these two signals permits low cost accurate tilt sensing to be achieved with the MEMSIC device (reference application note AN-00MX-007).

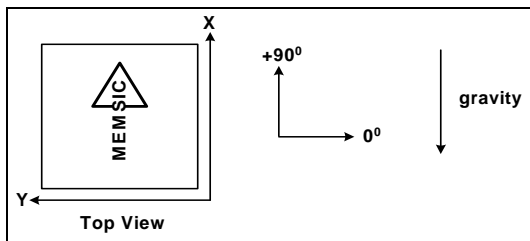

Figure 2: Accelerometer Position Relative to Gravity

X-Axis Orientation To Earth's Surface (deg.)	X-Axis		Y-Axis	
	X Output (g)	Change per deg. of tilt (mg)	Y Output (g)	Change per deg. of tilt (mg)
90	1.000	0.15	0.000	17.45
85	0.996	1.37	0.087	17.37
80	0.985	2.88	0.174	17.16
70	0.940	5.86	0.342	16.35
60	0.866	8.59	0.500	15.04
45	0.707	12.23	0.707	12.23
30	0.500	15.04	0.866	8.59
20	0.342	16.35	0.940	5.86
10	0.174	17.16	0.985	2.88
5	0.087	17.37	0.996	1.37
0	0.000	17.45	1.000	0.15

Table 1: Changes in Tilt for X- and Y-Axes

**Resolution:** Accelerometers can be used in a wide variety of low g applications such as tilt and orientation. The device noise floor will vary with the measurement bandwidth. With the reduction of the bandwidth the noise floor drops. This will improve the signal to noise ratio of the measurement and resolution. The output noise scales directly with the square root of the measurement bandwidth. The maximum amplitude of the noise, its peak-to-peak value, approximately defines the worst case

resolution of the measurement. With a simple RC low pass filter, the rms noise is calculated as follows:

$$\text{Noise (mg rms)} = \text{Noise(mg}/\sqrt{\text{Hz}}) * \sqrt{(\text{Bandwidth(Hz)} * 1.6)}$$

The peak-to-peak noise is approximately equal to 6.6 times the rms value (for an average uncertainty of 0.1%).

### DIGITAL INTERFACE

The MXD2020E/F is easily interfaced with low cost microcontroller. For the digital output accelerometer, one digital input port is required to read one accelerometer output. For the analog output accelerometer, many low cost microcontroller are available today that feature integrated a/d (analog to digital converters) with resolutions ranging from 8 to 12 bits.

In many applications the microcontroller provides an effective approach for the temperature compensation of the sensitivity and the zero g offset. Specific code set, reference designs, and applications notes are available from the factory. The following parameters must be considered in a digital interface:

**Resolution:** smallest detectable change in input acceleration  
**Bandwidth:** detectable accelerations in a given period of time

**Acquisition Time:** the duration of the measurement of the acceleration signal

### DUTY CYCLE DEFINITION

The MXD2020E/F has two PWM duty cycle outputs (x,y). The acceleration is proportional to the ratio T1/T2. The zero g output is set to 50% duty cycle and the sensitivity scale factor is set to 20% duty cycle change per g. These nominal values are affected by the initial tolerance of the device including zero g offset error and sensitivity error. This device is offered from the factory programmed to either a 10ms period (100 Hz) or a 2.5ms period (400Hz).

- T1 Length of the "on" portion of the cycle.
- T2 (Period) Length of the total cycle.
- Duty Cycle Ratio of the "On" time (T1) of the cycle to the total cycle (T2). Defined as T1/T2.
- Pulse width Time period of the "on" pulse. Defined as T1.

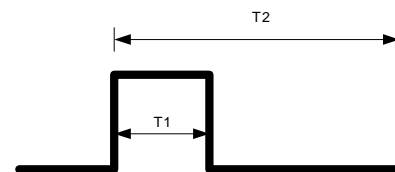

$$A (g) = (T1/T2 - 0.5) / 0.2$$

At 0g T1=T2

T2= 2.5ms or 10ms (factory programmable)

Figure 3: Typical output Duty Cycle

## CHOOSING T2 AND COUNTER FREQUENCY DESIGN TRADE-OFFS

The noise level is one determinant of accelerometer resolution. The second relates to the measurement resolution of the counter when decoding the duty cycle output. The actual resolution of the acceleration signal is limited by the time resolution of the counting devices used to decode the duty cycle. The faster the counter clock, the higher the resolution of the duty cycle and the shorter the T2 period can be for a given resolution. Table 2 shows some of the trade-offs. It is important to note that this is the resolution due to the microprocessors' counter. It is probable that the accelerometer's noise floor may set the lower limit on the resolution.

T2 (ms)	MEMSIC Sample Rate	Counter-Clock Rate (MHz)	Counts Per T2 Cycle	Counts per g	Resolution (mg)
10.0	100	1.0	10000	2000	0.5
10.0	100	0.5	5000	1000	1.0
2.5	400	1.0	2500	500	2.0
2.5	400	0.5	1250	250	4.0

Table 2: Trade-Offs Between Microcontroller Counter Rate and T2 Period.

## COMPENSATION FOR ZERO G OFFSET CHANGE OVER TEMPERATURE

The compensation of offset is performed with the following equation:  $A_{oc} = A + (a + b * T + c * T * T)$

where  $A_{oc}$  is the offset compensated acceleration,  $A$  is the uncompensated acceleration,  $T$  is temperature and  $a, b, c$  are constants characteristic to each accelerometer. Computer programs are used to determine these constants. The constants can be read from and written to the MCU EEPROM via the RS-232. The constants  $a, b, c$  are normally stored in the MCU EEPROM. To determine the values of the constants, each accelerometer is taken to three different temperatures, preferably evenly spread across the desired temperature span. The zero g bias ( $A_0, A_1$  and  $A_2$ ) and the temperatures ( $T_0, T_1$  and  $T_2$ ) are recorded at each temperature. The data collected ( $A_0, T_0, A_1, T_1, A_2, T_2$ ) is used in a quadratic interpolation (or LaGrange polynomial) to determine  $a, b$  and  $c$  as follows:

$$r_0 = A_0 / ((T_0 - T_1) * (T_0 - T_2))$$

$$r_1 = A_1 / ((T_1 - T_0) * (T_1 - T_2))$$

$$r_2 = A_2 / ((T_2 - T_0) * (T_2 - T_1))$$

$$a = r_0 * T_1 * T_2 + r_1 * T_0 * T_2 + r_2 * T_0 * T_1$$

$$b = -r_0 * (T_1 + T_2) - r_1 * (T_0 + T_2) - r_2 * (T_0 + T_1)$$

$$c = r_0 + r_1 + r_2$$

In many cases a computer is used to control the temperature, communicate with the MCU, and to calculate the constants. After calculating the constants, the computer downloads the constants to EEPROM.

For a more detail discussion of temperature compensation reference MEMSIC application note #AN-00MX-002

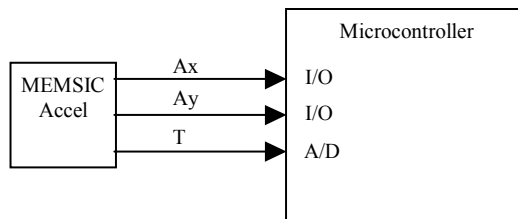

Figure 4: Zero g Offset Temperature Compensation Circuit

## COMPENSATION FOR EXTENDING THE FREQUENCY RESPONSE

The response of the thermal accelerometer is a function of the internal gas physical properties, the natural convection mechanism and the sensor electronics. Since the gas properties of MEMSIC's mass produced accelerometer are uniform, a digital filter can be used to equally compensate all sensors. The compensating filter does not require adjustment for individual accelerometers. The function of the compensating filter is to apply gain in proportion with the acceleration changes. The faster the acceleration changes occur, the higher the gain that the filter applies. For analog output accelerometers, the compensating filter can be implemented with a circuit involving two op-amps and some resistors and capacitors. For digital output accelerometers, a digital filter is necessary.

In applications where high frequency accelerations need to be measured, a DSP (digital signal processor) may be necessary to implement the digital filter. DSP IC's and development tools are readily available from major IC manufacturers.

However, if the bandwidth requirement is relatively low (i.e. 100Hz), it is possible to implement a digital frequency compensating filter with an 8 bit microcontroller. The microcontroller will likely have to be capable of operating at relatively high clock frequencies (20MHz).

## CONVERTING THE DIGITAL OUTPUT TO AN ANALOG OUTPUT

The PWM output can be easily converted into an analog output by integration. A simple RC filter can do the conversion. Note that that the impedance of the circuit following the integrator must be much higher than the impedance of the RC filter. Reference figure 5 for an example.

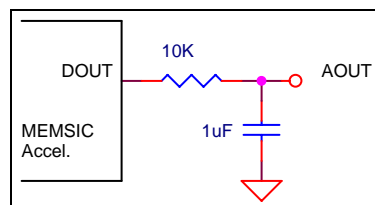

Figure 5: Converting the digital output to an analog voltage

### TEMPERATURE OUTPUT NOISE REDUCTION

It is recommended that a simple RC low pass filter is used when measuring the temperature output. Temperature output is typically a very slow changing signal, so a very low frequency filter eliminates erroneous readings that may result from the presence of higher frequency noise. A simple filter is shown in Figure 6.

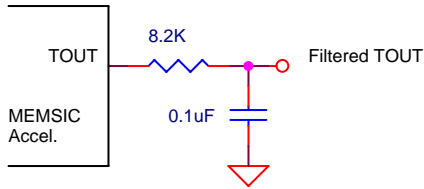

Figure 6: Temperature Output Noise Reduction

### POWER SUPPLY NOISE REJECTION

One capacitor is recommended for best rejection of power supply noise (reference Figure 7 below). The capacitor should be located as close as possible to the device supply pin ( $V_{DD}$ ). The capacitor lead length should be as short as possible, and surface mount capacitor is preferred. For typical applications, the capacitor can be ceramic 0.1  $\mu$ F.

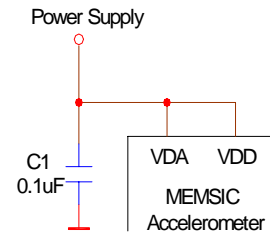
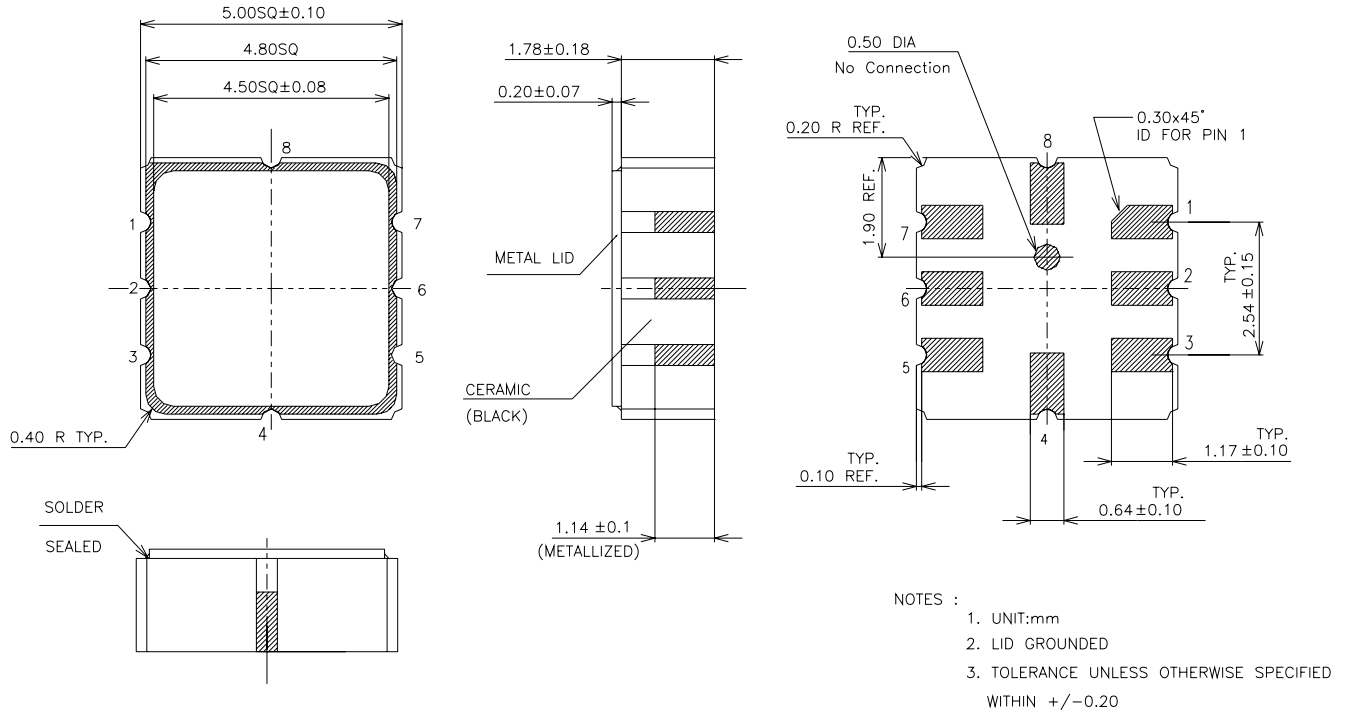

Figure 7: Power Supply Noise Rejection

### PCB LAYOUT AND FABRICATION SUGGESTIONS

1. The Sck pin should be grounded to minimize noise.
2. Liberal use of ceramic bypass capacitors is recommended.
3. Robust low inductance ground wiring should be used.
4. Care should be taken to ensure there is “thermal symmetry” on the PCB immediately surrounding the MEMSIC device and that there is no significant heat source nearby.
5. A metal ground plane should be added directly beneath the MEMSIC device. The size of the ground plane should be similar to the MEMSIC device’s footprint and be as thick as possible.
6. Vias can be added symmetrically around the ground plane. Vias increase thermal isolation of the device from the rest of the PCB.

**PACKAGE DRAWING**



*Fig 8: Hermetically Sealed Package Outline*